



ATLAS SYSTEM

DATA SHEET



EDITION: 2023 - REVIEW: 05

© 2023 - PERONI S.P.A.

All rights reserved.

The information and illustrations contained in this document may not be used, published or redistributed in any form without the prior written consent of Peroni S.p.A.

Subject to technical modifications without prior notice and errors excepted.

Illustrations of the product in this manual may differ from the actual product.

The colour of technical drawings is for illustration purposes only.

NOTE:

All units are in millimeters unless otherwise indicated.

INTRODUCTION

ATLAS is a professional modular system tailored for heavyweight stage curtains and scenic elements. Designed to accommodate large curtains, making it the ideal solution for a diverse range of settings, including theaters, studios, concert, trade fairs and beyond.

KEY FEATURES

VERSATILITY

EXTENSIVE CONFIGURATION OPTIONS AND CUSTOMIZED SOLUTIONS.

The ATLAS system is remarkably versatile, owing to its unique profile and comprehensive range of components. It offers a wide array of both straight and curved configurations, for single or overlapped operations.

The system's core support structure features an extruded aluminum profile renowned for its robustness, rigidity, and near-silent operation. This profile can be expertly curved with a minimum radius of just 100 cm.

All carriers come equipped with sealed ball bearings and a specialized covering, ensuring whisper-quiet operation. These notable attributes allow for seamless adaptation to diverse configurations and the fulfillment of your specific requirements.

In addition to the existing configuration options, tailor-made solutions can be developed to address specific needs for specialized applications.

FIXING OPTIONS

STREAMLINED INSTALLATION WITH OUR SUSPENSION ACCESSORIES

The ATLAS system offers a comprehensive selection of suspension accessories carefully crafted to simplify the installation process and accommodate various installation scenarios:

- Flying Bar Systems: Choose from hook clamps or pipe collars for secure suspension.
- Beam Clamps: Use them to attach to girders and beams, ensuring stability and flexibility.
- Wall Mounting: Utilize wall brackets for sturdy attachment to vertical surfaces.
- Ceiling Mounting: Opt for studding bars to suspend from ceilings with ease.
- Ropes/Wires Suspension: Use lifting eyebolts for versatile suspension options.

With ATLAS's wide range of suspending accessories, you can seamlessly install the system in diverse settings, making it suitable for a wide array of installation conditions.

DRIVE MODES

FROM MANUAL TO MOTORIZED SOLUTIONS

The ATLAS system offers versatile operation, allowing you to choose from various methods, whether manual or motorized:

- Walk-Along System: This manual option enables you to operate the system by simply pulling one edge of the curtain.
- Corded Manual System: Utilize a hauling line, which can be manually operated using a floor pulley or a hand winch, providing precise control.
- Corded Motorized System: Experience the convenience of automation with an electric drive system that effortlessly operates the hauling line.

With the ATLAS system, you have the flexibility to select the operation method that best suits your needs, whether it's hands-on manual control or the efficiency of motorized automation.



SURFACE FINISHING

PROFESSIONAL MATT BLACK

All key components feature a matte black finish to minimize light reflection on the stage. The aluminum profile is finished with a sleek black anodized coating, and all steel parts are meticulously coated in a durable black powder finish.

TECHNICAL SPECIFICATIONS

TRACK LOAD CAPACITY

Span [cm]	 Centre Point Load [kg]	 Uniformly Distributed Load	
		Total Load [kg]	Load per meter [kg/m]
100	362	723	723
150	241	483	322
200	181	362	181
250	145	290	116
300	121	240	80

The table presents data for the maximum allowable loads applicable to the track only, according to a safety factor of 5.

When calculating the allowable loads listed in the table, it is assumed that the track is simply supported at the end connection. Please note that these are idealized loading conditions and these values are to be considered as indicative.

The track, the carriers and all suspending components are load bearing elements of the system and the load capacity of each component must be taken into account. Keep in mind that the overall load capacity of the system is determined by its weakest element.

It's essential to also consider the suitability and load-carrying capacity of the supporting structures (such as walls, ceilings, bars, trusses).

COMPONENTS LOAD CAPACITY

Art.	Description	WLL Working Load Limit [kg]
1A04	Overlap Bracket	80
1A05	Offset Fixing Plate	80
1A10	Master Carrier	50
1A11	Master Carrier	50
1A12	Master Carrier	50
1A14	Master Carrier	50
1A20	2-Wheel Runner	20
1A21	4-Wheel Runner	20
1A24	Heavy Duty Carrier	150
1A25	Scenery Attachment Clamp	150
1A60	Suspension Bracket	80
1A61	Suspension Bracket	80
1A63	Hook Clamp	60
1A64	Hook Clamp	60
1A66	Suspension Eye Nut	150
1Z10-250	Wall Bracket 250 mm	50
1Z10-400	Wall Bracket 400 mm	30
1Z20	Beam Clamp	500

COMPONENTS AND ACCESSORIES

TRACKS

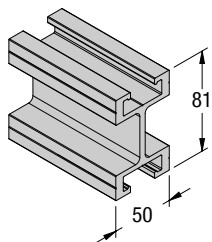

1A01 · STRAIGHT TRACK

INFO		FEATURES
WEIGHT	3,12 kg/m	<ul style="list-style-type: none"> · Extruded aluminium profile, black anodised · 'T' channel in the top and bottom to fix the components · Available in full length bars or custom cuts
MAX BAR LENGHT	600 cm	
MAX SPAN	300 cm	
MIN CURVE RADIUS	100 cm	

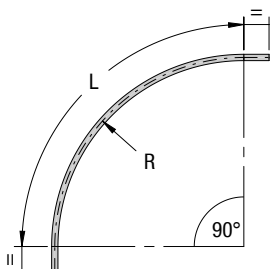

1A01C · CURVED TRACK

INFO		R	L	WEIGHT	FEATURES
1A01C-100	90° Curve	100 cm	157 cm	6,2 kg	
1A01C-200	90° Curve	200 cm	314 cm	11,0 kg	
1A01C-300	90° Curve	300 cm	471 cm	16,0 kg	
1A01C-X	Custom	Custom radius and angle			

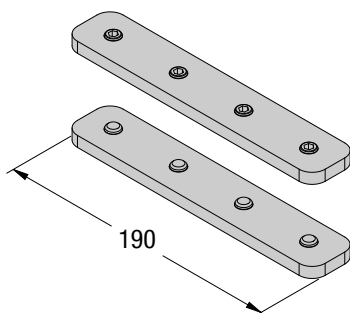

1A02 · JOINT SET

INFO	FEATURES	FUNCTION
COLOUR – Zinc plated WEIGHT – 830 g	<ul style="list-style-type: none"> · 2 plates included, each with four M10 socket screw 	<ul style="list-style-type: none"> · Connect and align two adjacent sections of track together

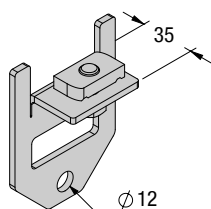

1A03 · END STOP

INFO	FEATURES	FUNCTION
COLOUR – Matt black WEIGHT – 245 g	<ul style="list-style-type: none"> · Channel Nut included 	<ul style="list-style-type: none"> · Stop the carriers at the ends of the track · Anchor point to secure the offstage end of the curtain

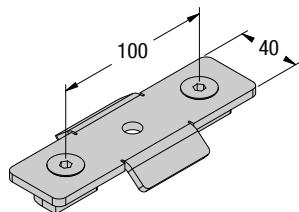

1A04 · OVERLAP BRACKET

INFO	FEATURES	FUNCTION
COLOUR – Matt black WEIGHT – 365 g WLL – 80 kg	<ul style="list-style-type: none"> · Overlap steel plate · 2 Channel Nut included 	<ul style="list-style-type: none"> · Join and ensure parallel alignment between two track sections. · Always used in pairs

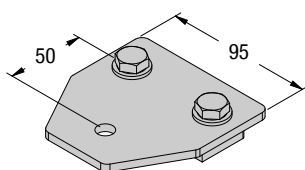

1A05 · OFFSET FIXING PLATE

INFO	FEATURES	FUNCTION
COLOUR – Matt black WEIGHT – 428 g WLL – 80 kg	<ul style="list-style-type: none"> · 50 mm offset distance · 2 Channel Nut included 	<ul style="list-style-type: none"> · For suspending an overlap track from a single pipe, ensures central positioning of the track beneath the pipe. · Designed for use with 1A60 hook clamps or threaded bar.

CARRIERS

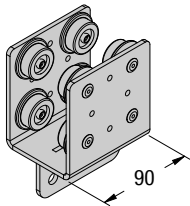

1A10 · MASTER CARRIER

INFO	FEATURES	FUNCTION
COLOUR – Matt black WEIGHT – 926 g WLL – 50 kg	<ul style="list-style-type: none"> · steel body · 8 ball bearing flanged wheels 	<ul style="list-style-type: none"> · Leading carrier for walk-along curtain (system without cord operation)

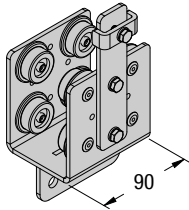

1A11 · MASTER CARRIER

INFO	FEATURES	FUNCTION
COLOUR – Matt black WEIGHT – 1.082 g WLL – 50 kg	<ul style="list-style-type: none"> · steel body · 8 ball bearing flanged wheels · straight arm with rope clamp 	<ul style="list-style-type: none"> · Leading carrier for top cord offset operation

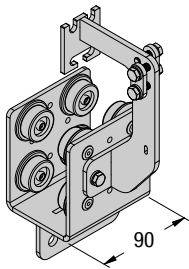

1A12 · MASTER CARRIER

INFO	FEATURES	FUNCTION
COLOUR – Matt black WEIGHT – 1.340 g WLL – 50 kg	<ul style="list-style-type: none"> · steel body · 8 ball bearing flanged wheels · C-shaped arm with rope clamps 	<ul style="list-style-type: none"> · Leading carrier for top cord operation (curved layout or straight overlapped track)

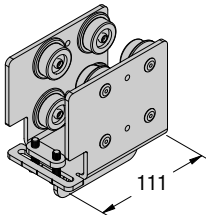

1A14 · MASTER CARRIER

INFO	FEATURES	FUNCTION
COLOUR – Matt black WEIGHT – 1.065 g WLL – 50 kg	<ul style="list-style-type: none"> · steel body · 8 ball bearing flanged wheels · adjustable rope clamp 	<ul style="list-style-type: none"> · Leading carrier for bottom cord operation

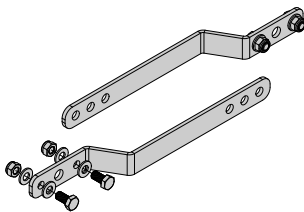

1A15 · OVERLAP ARMS KIT

INFO	FEATURES	FUNCTION
COLOUR – Matt black WEIGHT – 1.000 g WLL – 10 kg	<ul style="list-style-type: none"> · 2 overlap arms for master carriers · screws, washers and nuts included 	<ul style="list-style-type: none"> · Designed to be fixed to the side of master carriers for an approximately 50 cm curtain overlap on single track configuration

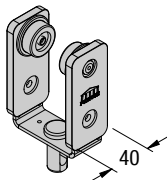

1A20 · 2-WHEEL RUNNER

INFO	FEATURES	FUNCTION
COLOUR – Matt black WEIGHT – 246 g WLL – 25 kg	<ul style="list-style-type: none"> · steel body · 2 ball bearing flanged wheels · rubber damper blocks · swivel attachment for curtain 	<ul style="list-style-type: none"> · For use on straight track

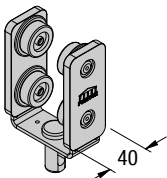

1A21 · 4-WHEEL RUNNER

INFO	FEATURES	FUNCTION
COLOUR – Matt black WEIGHT – 287 g WLL – 25 kg	<ul style="list-style-type: none"> · steel body · 4 ball bearing flanged wheels · rubber damper blocks · swivel attachment for curtain 	<ul style="list-style-type: none"> · For use on curved track

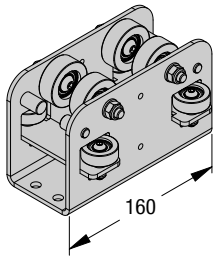

1A24 · HEAVY DUTY CARRIER

INFO	FEATURES	FUNCTION
COLOUR – Matt black WEIGHT – 1.775 kg WLL – 150 kg	<ul style="list-style-type: none"> · steel body · 4 contact wheels with ball bearings · 4 guide wheels with ball bearings · equipped with wheel failure safety blocks 	<ul style="list-style-type: none"> · Scenery carrier for heavy load · Used in conjunction with 1A25

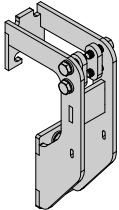

1A24B · ROPE CLAMPING ARM

INFO	FEATURES	FUNCTION
COLOUR – Matt black WEIGHT – 560 g	<ul style="list-style-type: none"> · steel body 	<ul style="list-style-type: none"> · Heavy duty arm for top cord operation · Used in conjunction with 1A24

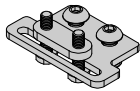

1A24D · ROPE CLAMPING PLATE

INFO	FEATURES	FUNCTION
COLOUR – Matt black WEIGHT – 130 g	<ul style="list-style-type: none"> · steel body 	<ul style="list-style-type: none"> · Rope clamp for bottom cord operation · Used in conjunction with 1A24

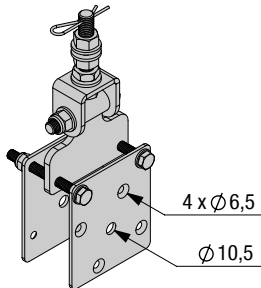

1A25 · SCENERY ATTACHMENT CLAMP

INFO	FEATURES	FUNCTION
COLOUR – Matt black WEIGHT – 995 g WLL – 150 kg	<ul style="list-style-type: none"> · solid steel body · standard clampable thickness 7-50 mm (other thicknesses on request) · swivel pin (lockable if needed) · hinge for ground assembly of scenery · safety spring cotter pin 	<ul style="list-style-type: none"> · Adjustable clamp for carrying of scenery like panels or frames

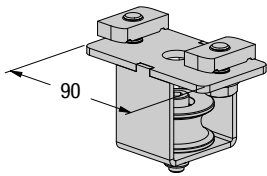

1A30 · RETURN PULLEY

INFO	FEATURES	FUNCTION
<p>COLOUR – Matt black WEIGHT – 440 g</p>	<ul style="list-style-type: none"> · steel body · diverting pulley with ball bearings · U-groove sheave for 8 mm rope · 2 channel nuts included 	<ul style="list-style-type: none"> · Designed for bottom cord single track configuration to divert the operating line back to 1A31 head pulley

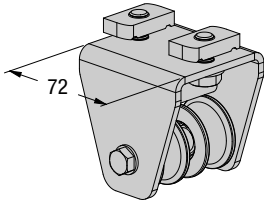

1A31 · HEAD PULLEY

INFO	FEATURES	FUNCTION
<p>COLOUR – Matt black WEIGHT – 650 g</p>	<ul style="list-style-type: none"> · steel body · 2 diverting pulleys with ball bearings · U-groove sheave for 8 mm rope · 2 channel nuts included 	<ul style="list-style-type: none"> · Designed for bottom cord single track configuration to divert 90° downward the operating lines

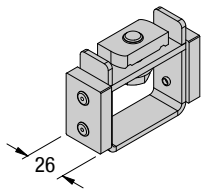

1A32 · CENTRAL CORD PICKUP

INFO	FEATURES	FUNCTION
<p>COLOUR – Matt black WEIGHT – 195 g</p>	<ul style="list-style-type: none"> · steel body · 2 rubber damper blocks · channel nut included 	<ul style="list-style-type: none"> · Designed for bottom cord single track configuration to supports the ropes from sagging at the center of the system. · It offers shock absorption when in contact with master carriers

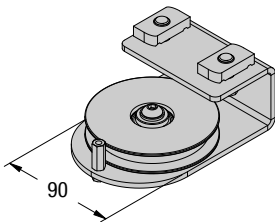

1A33 · OFFSET RETURN PULLEY

INFO	FEATURES	FUNCTION
<p>COLOUR – Matt black WEIGHT – 850 g</p>	<ul style="list-style-type: none"> · steel body · diverting pulley with ball bearing · U-groove sheave for 8 mm rope · 2 channel nuts included 	<ul style="list-style-type: none"> · Designed for bottom cord double track configuration to divert the operating line back to 1A34 head pulley

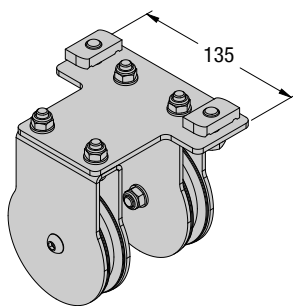

1A34 · OFFSET HEAD PULLEY

INFO	FEATURES	FUNCTION
<p>COLOUR – Matt black WEIGHT – 1.703 g</p>	<ul style="list-style-type: none"> · steel body · 2 diverting pulleys with ball bearings · U-groove sheave for 8 mm rope · 2 channel nuts included 	<ul style="list-style-type: none"> · Designed for bottom cord double track configuration to divert 90° downward the operating lines

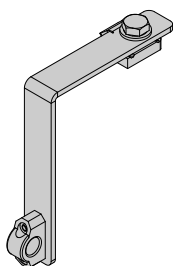

1A35 · LINE GUIDE

INFO	FEATURES	FUNCTION
<p>COLOUR – Matt black WEIGHT – 266 g</p>	<ul style="list-style-type: none"> · steel body · low friction plastic guide · channel nut included 	<ul style="list-style-type: none"> · Designed for bottom cord double track configuration to guide and prevent the operating line from sagging

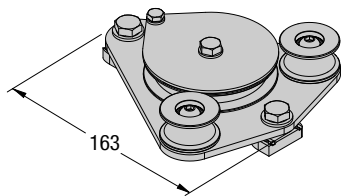

1A40 · RETURN PULLEY

INFO	FEATURES	FUNCTION
COLOUR – Matt black WEIGHT – 1.100 g	<ul style="list-style-type: none"> · steel body · diverting pulley with ball bearing · 2 guiding rollers with ball bearings · U-groove sheave for 8 mm rope · 2 channel nuts included 	<ul style="list-style-type: none"> · Designed for top cord configuration to divert the operating line back to 1A41 head pulley

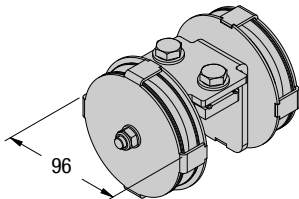

1A41 · HEAD PULLEY

INFO	FEATURES	FUNCTION
COLOUR – Matt black WEIGHT – 1.166 g	<ul style="list-style-type: none"> · steel body · 2 diverting sheaves with ball bearings · U-groove sheave for 8 mm rope · 2 channel nuts included 	<ul style="list-style-type: none"> · Designed for top cord configuration to divert 90° downward the operating lines

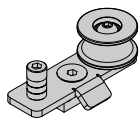

1A42 · OVERLAP CORD GUIDE

INFO	FEATURES	FUNCTION
COLOUR – Matt black WEIGHT – 227 g	<ul style="list-style-type: none"> · steel body · guiding pulley with ball bearings · U-groove sheave for 8 mm rope · channel nut included 	<ul style="list-style-type: none"> · Designed for top cord configuration to guide the operating line through the track overlap

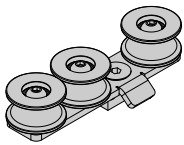

1A43 · CORD GUIDE

INFO	FEATURES	FUNCTION
COLOUR – Matt black WEIGHT – 353 g	<ul style="list-style-type: none"> · steel body · 3 guiding pulleys with ball bearings · U-groove sheave for 8 mm rope · channel nut included 	<ul style="list-style-type: none"> · Designed for curved track and for double track configuration (offset overlap) to guide and support the operating line along the track

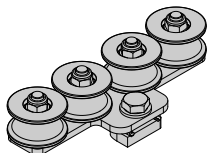

1A44 · HEAD PULLEY ALIGNER

INFO	FEATURES	FUNCTION
COLOUR – Matt black WEIGHT – 505 g	<ul style="list-style-type: none"> · steel body · 4 guiding pulley with ball bearings · U-groove sheave for 8 mm rope · channel nut included 	<ul style="list-style-type: none"> · Designed for top cord configuration to ensure alignment of the operating and returning cords with 1A40 head pulley

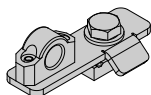

1A48 · OFFSET LINE GUIDE

INFO	FEATURES	FUNCTION
COLOUR – Matt black WEIGHT – 136 g	<ul style="list-style-type: none"> · steel body · for 8 mm rope · low friction plastic guide · channel nut included 	<ul style="list-style-type: none"> · Designed for offset top cord operation (straight single track) to guide and prevent the returning rope from sagging

6.4 · FLOOR PULLEYS

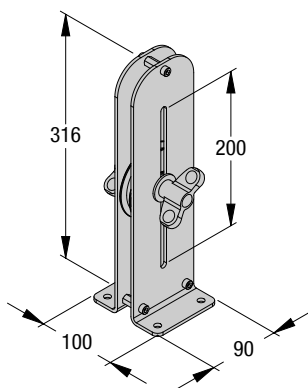

1Z01 · ADJUSTABLE FLOOR PULLEY

INFO	FEATURES	FUNCTION
<p>COLOUR – Matt black WEIGHT – 2,1 kg EXCURSION – 200 mm</p>	<ul style="list-style-type: none"> · steel body · U-groove sheave for 8 mm rope · 2 wing knobs for quick adjustments · Ø8,5 mm holes to fix the pulley (ground fixing fasteners not included) 	<ul style="list-style-type: none"> · Designed to manually operate the hauling line of corded systems · It allows for adjusting the tension of the rope

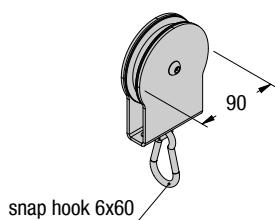

1Z02 · WEIGHT FLOOR PULLEY

INFO	FEATURES	FUNCTION
<p>COLOUR – Matt black WEIGHT – 620 g WLL – 40 kg</p>	<ul style="list-style-type: none"> · steel body · diverting pulley with ball bearing · U-groove sheave for 8 mm rope · 6 x 60 mm snap hook included 	<ul style="list-style-type: none"> · Single wheeled pulley equipped with a snap hook for attaching a ballast (not included), usually a 5 or 10 kg sandbag. · It is generally used where it is not possible to fix a permanent pulley to the floor.

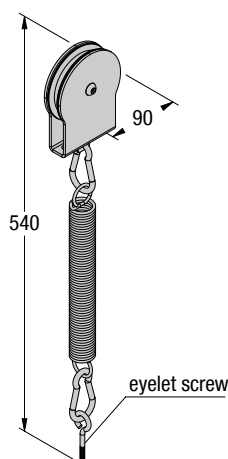

1Z03 · SPRING LOADED FLOOR PULLEY

INFO	FEATURES	FUNCTION
<p>COLOUR – Matt black WEIGHT – 965 g</p>	<ul style="list-style-type: none"> · steel body · diverting pulley with ball bearing · U-groove sheave for 8 mm rope · Supplied as standard with eyelet screw for wooden floor fixing. 	<ul style="list-style-type: none"> · Fixed floor pulley equipped with traction spring to maintain a constant tension on manual hauling line. · On request, it can be equipped with a different type of fixing screw.

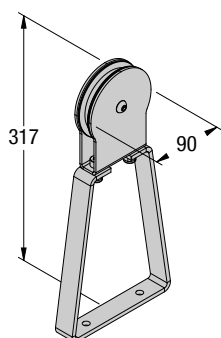

1Z04 · FLOOR PULLEY WITH FOOT STIRRUP

INFO	FEATURES	FUNCTION
<p>COLOUR – Matt black WEIGHT – 1.179 g</p>	<ul style="list-style-type: none"> · steel body · diverting pulley with ball bearing · U-groove sheave for 8 mm rope · Ø8,5 mm holes to fix the pulley (ground fixing fasteners not included) 	<ul style="list-style-type: none"> · Suspended pulley at floor level, with a stirrup tensionable by foot pressure. · Provided with two holes for floor fixing if needed.

SUSPENSION PARTS

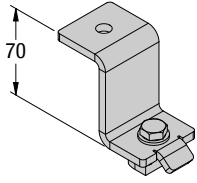

1A60 · SUSPENSION BRACKET

INFO	FEATURES	FUNCTION
COLOUR – Matt black WEIGHT – 380 g WLL – 80 kg	<ul style="list-style-type: none"> · steel body · channel nut included 	<ul style="list-style-type: none"> · Designed for offset top cord operation (straight single track)

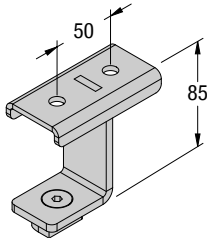

1A61 · SUSPENSION BRACKET

INFO	FEATURES	FUNCTION
COLOUR – Matt black WEIGHT – 480 g WLL – 80 kg	<ul style="list-style-type: none"> · steel body · channel nut included 	<ul style="list-style-type: none"> · Designed for curved track and for double track configuration (offset overlap)

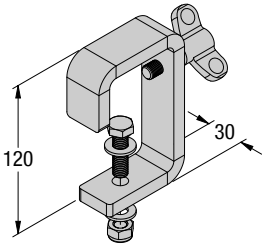

1A63 · HOOK CLAMP

INFO	FEATURES	FUNCTION
COLOUR – Matt black WEIGHT – 690 g WLL – 60 kg	<ul style="list-style-type: none"> · steel body · fastener set for suspension bracket included 	<ul style="list-style-type: none"> · Clamp for 50mm tube or truss · In combination with 1A04, 1A05, 1A60, 1A61, 1A65

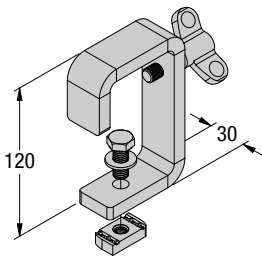

1A64 · HOOK CLAMP WITH CHANNEL NUT

INFO	FEATURES	FUNCTION
COLOUR – Matt black WEIGHT – 705 g WLL – 60 kg	<ul style="list-style-type: none"> · steel body · screw, washer and channel nut included 	<ul style="list-style-type: none"> · Clamp for 50mm tube or truss complete with channel nut for direct track fixing

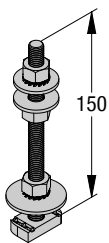

1A65 · STUDDING BAR

INFO	FEATURES	FUNCTION
COLOUR – Matt black LENGTH – 150 mm WEIGHT – 185 g	<ul style="list-style-type: none"> · M10x150 threaded rod c/w channel nut, washers and nuts · Other lengths available on request 	<ul style="list-style-type: none"> · For direct track fixing

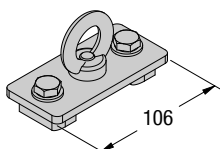

1A66 · SUSPENSION EYENUT

INFO	FEATURES	FUNCTION
COLOUR – Matt black WEIGHT – 470 g WLL – 150 kg	<ul style="list-style-type: none"> · steel body · M10 eyebolt · 2 channel nuts included 	<ul style="list-style-type: none"> · Designed for lifting and suspending track sections using wire rope or chains

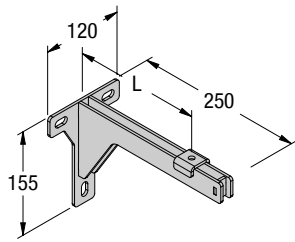

1Z10 · WALL BRACKET 250 mm

INFO	FEATURES	FUNCTION
COLOUR – Matt black LENGHT – 250 mm WEIGHT – 950 g WLL – 50 kg	<ul style="list-style-type: none"> · steel body · screw, washer and channel nut included · adjustable distance 	<ul style="list-style-type: none"> · Clamp for 50mm tube or truss complete with channel nut for direct track fixing

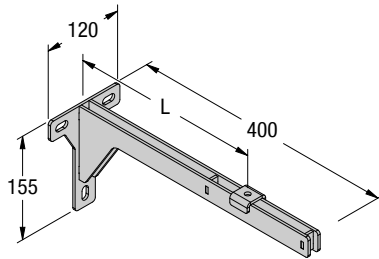

1Z10 · WALL BRACKET 400 mm

INFO	FEATURES	FUNCTION
COLOUR – Matt black LENGHT – 400 mm WEIGHT – 1.250 g WLL – 30 kg	<ul style="list-style-type: none"> · steel body · screw, washer and channel nut included · adjustable distance 	<ul style="list-style-type: none"> · Clamp for 50mm tube or truss complete with channel nut for direct track fixing

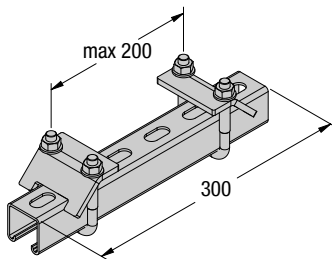

1Z20 · BEAM CLAMP

INFO	FEATURES	FUNCTION
COLOUR – Matt black LENGHT – 300 mm WEIGHT – 1.340 g WLL – 500 kg vertical	<ul style="list-style-type: none"> · 41x41x300 mm steel slotted bar, powder coated in black · steel clamps, powder coated in black · U-bolts with M10 nuts and washers 	<ul style="list-style-type: none"> · Designed for suspending the track from metal I-beams, this system is adjustable to accommodate various beam sizes, with a maximum width of up to 200mm (other sizes available upon request) · Used in combination with studding



3E8 · POLYESTER ROPE

INFO	FEATURES	FUNCTION
COLOUR – Matt black WEIGHT – 50 g/m REEL LENGHT – 200 m	<ul style="list-style-type: none"> · 8 mm diameter · 100% high tenacity polyester fiber · available in cut lenghts or in reel 	<ul style="list-style-type: none"> · Operating rope for manual or motorised system

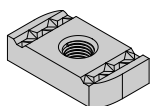

1A00 · CHANNEL NUT

INFO	FEATURES	FUNCTION
COLOUR – Zinc plated WEIGHT – 33 g	<ul style="list-style-type: none"> · 90° rotating nut · M10 threaded hole (M12 available upon request) 	<ul style="list-style-type: none"> · Used to fix all components into the T-channels of the track

LIMIT SWITCHES

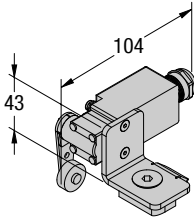

1A70 · LIMIT SWITCH

INFO	FEATURES	FUNCTION
<p>COLOUR – Matt black WEIGHT – 275 g (cable excluded)</p>	<ul style="list-style-type: none"> · Track mounting plate · Limit switch c/w cable and connector · Pre-wired in factory 	

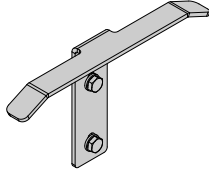

1A71 · LIMIT SWITCH ARM

INFO	FEATURES	FUNCTION
<p>COLOUR – Matt black WEIGHT – 160 g</p>	<ul style="list-style-type: none"> · Screws, washers included 	<ul style="list-style-type: none"> · Limit switch arm for bottom and top cord operation · In combination with 1A70

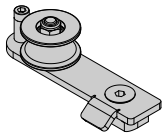

1A72 · CORD GUIDE FOR LIMIT SWITCH

INFO	FEATURES	FUNCTION
<p>COLOUR – Matt black WEIGHT – 260 g</p>	<ul style="list-style-type: none"> · Guiding sheave with ball bearings · For 8 mm rope · Channel nut included 	<ul style="list-style-type: none"> · For top cord operation, guide the rope around the limit switch · In combination with 1A70

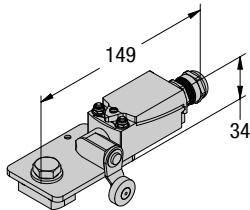

1A73 · LIMIT SWITCH

INFO	FEATURES	FUNCTION
<p>COLOUR – Matt black WEIGHT – 300 g (cable excluded)</p>	<ul style="list-style-type: none"> · Track mounting plate · Limit switch c/w cable and connector · Pre-wired in factory 	<p>For offset top cord operation</p>

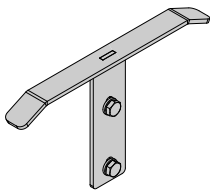

1A74 · LIMIT SWITCH ARM

INFO	FEATURES	FUNCTION
<p>COLOUR – Matt black WEIGHT – 157 g</p>	<ul style="list-style-type: none"> · Screws, washers included 	<ul style="list-style-type: none"> · Limit switch arm for offset top cord operation · In combination with 1A73

2DR1 · MOTOR UNIT

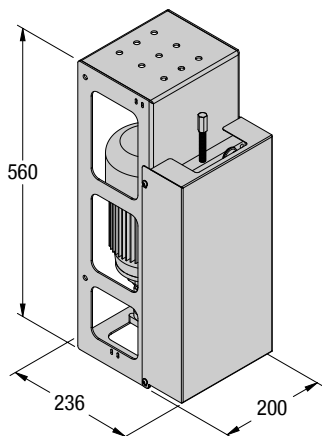

INFO
<p>COLOUR – Matt black WEIGHT – 17,5 kg DIMENSIONS (W x H x D) – 236 x 200 x 560 mm</p> <p>POWER – 0,37 kW TORQUE – 22 Nm VOLTAGE – 3 x 230/400 VAC FREQUENCY – 50 Hz MAX SPEED – 1,0 m/s MAX CURTAIN WEIGHT – 300 kg straight layout / 200 kg curved layout</p>

FEATURES
<ul style="list-style-type: none"> · Connector for extension cable · Pre-wired for 2 limit switches with XLR connectors · Wall mounting brackets
OPTIONS
<ul style="list-style-type: none"> · Automatic release device for manual operation

2QE · CONTROL UNIT

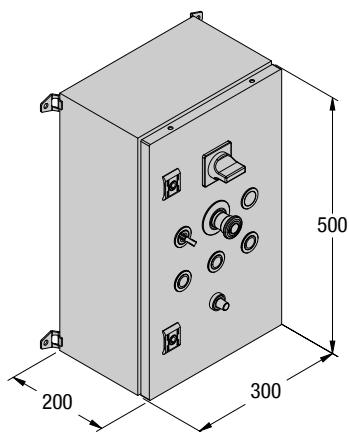

MODEL	INFO
M230V0-S Standard Unit	<p>DIMENSIONS (W x H x D) – 300 x 500 x 215 mm WEIGHT – 13,0 kg VOLTAGE – 1 x 230 VAC FREQUENCY – 50 Hz WALL BRACKETS INCLUDED</p>
M230V0-D DMX Unit	<p>DIMENSIONS (W x H x D) – 300 x 500 x 215 mm WEIGHT – 13,0 kg VOLTAGE – 1 x 230 VAC FREQUENCY – 50 Hz WALL BRACKETS INCLUDED</p>

FEATURES
<ul style="list-style-type: none"> · open/stop/close · speed adjustment · emergency stop button · local/remote selector · motor reverse switch · remote pendant ready · radio control ready
<ul style="list-style-type: none"> · open/stop/close · speed adjustment · emergency stop button · DMX interface · local/remote/DMX selector · motor reverse switch · remote pendant ready · radio control ready

2QEM · EXTENSION CABLE

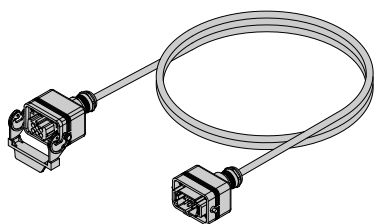

INFO	FEATURES
<p>COLOUR – Grey WEIGHT – 2,15 kg</p>	<ul style="list-style-type: none"> · metal connectors · 15 m standard cable length · custom length available on request

FUNCTION
<ul style="list-style-type: none"> · Power and control cable to connect the motor unit with the control cabinet

REMOTE CONTROLLER

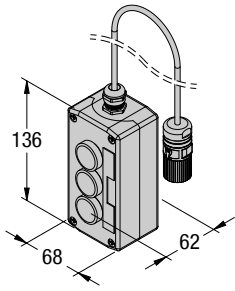

2QER-01 · REMOTE PENDANT

INFO

DIMENSIONS (W x H x D) – 68 x 136 x 62 mm
WEIGHT – 1 kg

FEATURES

- open/stop/close
- pre-wired in factory with connector
- 15 m standard cable length
- custom length available on request

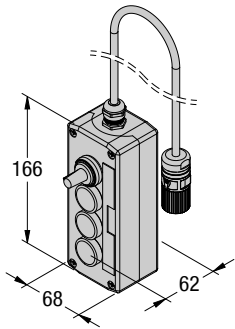

2QER-02 · REMOTE PENDANT WITH SPEED ADJUSTMENT

INFO

DIMENSIONS (W x H x D) – 68 x 166 x 62 mm
WEIGHT – 1,65 kg

FEATURES

- open/stop/close
- potentiometer for speed adjustment
- pre-wired in factory with connector
- 15 m standard cable length
- custom length available on request

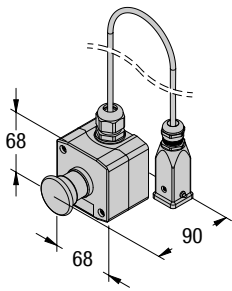

2QER-ESB · REMOTE EMERGENCY STOP BOTTON

INFO

DIMENSIONS (W x H x D) – 68 x 68 x 90 mm
WEIGHT – 1,30 kg

FEATURES

- remote emergency stop botton for DMX
- 25 m standard cable length
- custom length available on request

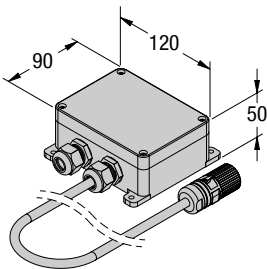

2RCR · RADIO CONTROL RECEIVER

INFO

DIMENSIONS (W x H x D) – 120 x 90 x 50 mm
WEIGHT – 610 g

FEATURES

- voltage 12/24 VDC
- frequency 2,4 GHz, 16 Channels
- IP66
- pre-wired in factory with connector for 2QE
- 2 m standard cable length



2RCT · RADIO CONTROL TRANSMITTER

INFO

DIMENSIONS (W x H x D) – 65 x 112 x 35 mm
WEIGHT – 130 g

FEATURES

- frequency 2,4 GHz, 16 Channels
- IP65
- open/stop/close buttons
- ON/OFF switch
- battery: 2 x 1,5V AAA / LR03



For more technical support,
please contact our corporate office.

PERONI S.P.A.
Via Monte Leone, 93
21013 Gallarate (VA) Italy
Tel. +39 0331 756811
Fax +39 0331 776260
email: info@peroni.com
www.peroni.com